

The English Inspectorate

The Charedi District

Presents

The Sivan Booklet

5779

Stories and Midrashim in English

Written and Compiled by Aron Cohen

Write the Hebrew word next to the correct English word.

job	
wear	
every	
get (got)	
must	

	ללבוש
	לקבל
	חייב
	כל
	עבודה

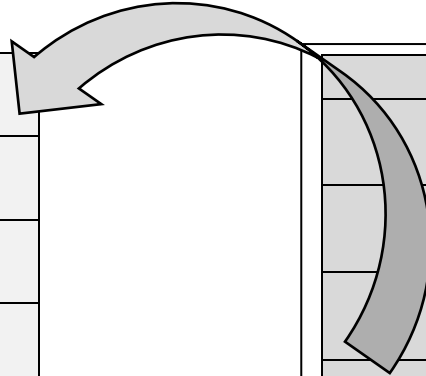

Write the words in the order of the alphabet.

every

The underlined words are in the wrong sentences. Write them in the correct sentences.

job

1. My father starts his wears at 7am.
2. He learns Torah got day.
3. In the winter, he every a big jacket.
4. He must his tefillin for his bar-mitzvah.
5. They job finish eating breakfast by 8 am.

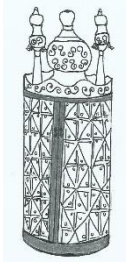

Name the Parasha

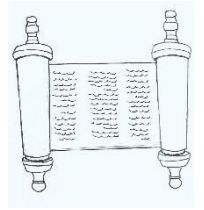

Read the six sentences. Under each sentence, write down the name of the correct *parasha*.

(Hint: from *parashat Behar* until *parashat Shlach Lecha*)

Behar

Bechukotai

Bamidbar

Nasso

Behalotecha

Shelach Lecha

1) Hashem told Moshe the jobs of *Shevet Levy*.

Parashat: _____

פינה - corner

חולצה - shirt

2) Hashem told Bnei Yisrael to wear *tzitzit* on a shirt with four corners.

Parashat: _____

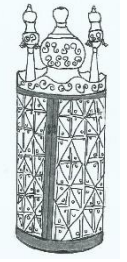
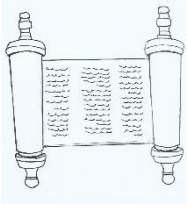

3) Every Jew must give *ma'aser behema*.

Parashat: _____

4) *Shmittah* is every seven years.

Parashat: _____

יהודי - Jew

עור - skin

5) Miriam got *tzara'at* on her skin.

Parashat: _____

6) Hashem told the *Kohanim* that they have
a *mitzvah* to bless *Bnei Yisrael*.

Parashat: _____

Write the meaning of the new word next to the word in English.

New Words

ask

have to

keep

another

a piece of land

a farmer

give away

hard

once

same thing

take care of

there was

too

פעם

מדוי

קשה

היה

לתת בחינם

אותו דבר

לשאול

לטפל

חייב

לקיים/לשמור

אחר

חקלאי

שטח אדמה

Write the correct word next to the sentence.

1. A person who works the land.

2. I don't want money for it- just take it.

3. It happened in the past.

4. Another word for "must".

5. The opposite of "easy".

6. If you don't know then ____.

7. Can you ____ it until I come back?

8. Even if it's ___ hard, try and try again.

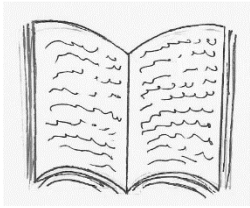

Do What You Promise

(Adapted from the Midrash Rabbah Shemot: 27:9)

A

Hashem asked the nations if they wanted the Torah, but they all said no. Then Hashem asked *Bnei Yisrael*. They accepted the Torah and promised to keep it.

But once *Bnei Yisrael* promised to keep the Torah, they must keep their promise.

accept- לקבל

nation- אומה

promise- להבטיח

- 1) After *Bnei Yisrael* promised to accept the Torah, they have to _____

B

Here's a parable to explain this idea.

Once there was a king. He owned a piece of land.

The king wanted to give away this land to a farmer.

The king called a farmer and asked him, "Do you want this land?"

The farmer answered, "No, I don't want the land. It will be too hard for me to take care of it."

The king asked another farmer, and another farmer,

owned- היה בעלים של

parable- משל

- 2) What did the king want to give away?

- 3) Why did the farmer say no to the king?

and another farmer, and they all said the same thing, "No, we don't want the land."

Write the Hebrew meaning next to its English meaning.

didn't do anything

himself

this time

angry

work

mean

show

keep a promise

את עצמו

להתכוון

לקיים הבטחה

להראות

הפעם

לא עשה כלום

לעבוד

כועס

Fill in the puzzle with the correct word.

Do What You Promise

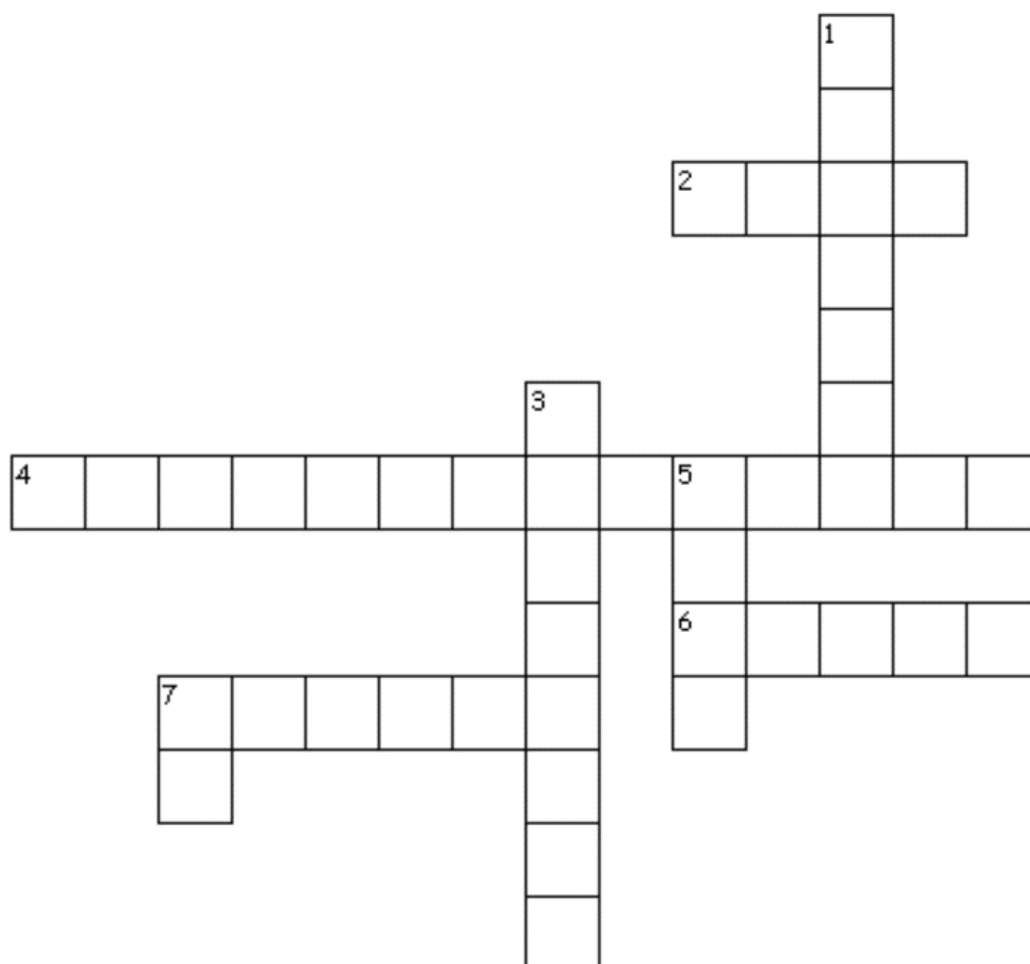

Across

- 2. להראות
- 4. עצמו
- 6. כועס
- 7. לא

Down

- 1. הבטחה
- 3. הפעם
- 5. להתכוון
- 7. לעשות

C

Then the king called another farmer, the fifth farmer.

This time his answer was different.

The king asked him, "Do you want this land?"

The farmer answered, "Yes, I'll take it."

The king asked him, "And will you take care of the land?"

The farmer replied, "Yes, I will."

When the farmer took over the land, he didn't work the land at all. He didn't do anything.

להעתיק - copy

חמישי - fifth

לענות - reply

לקבל לידי - take over (took over)

4) The fifth farmer answered and said "Yes, I'll take it."
What does he mean?

5) Did the farmer keep his promise?
YES or NO

Copy the words that helped you answer the question.

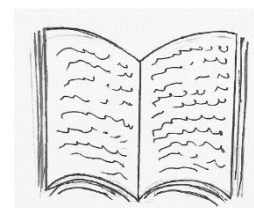

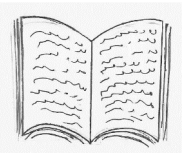

D

Who would the king be very angry with?

With the farmers who said they don't want the land or with the farmer who said he would take the land, but didn't work it?

The answer is with the farmer who said he would take the land but didn't work it.

discuss- לדון

explain- להסביר

paragraph- פסקה

would- היה

6) Explain the question in paragraph D.

7) Why do you think the answer is the farmer who didn't work the land? Discuss your answer in class.

E

This is just like what happened when Hashem showed Himself at *Har Sinai*. Hashem asked all the nations if they wanted the Torah and they all said no. But when Hashem asked Bnei Yisrael if they wanted the Torah, they accepted it and said, "Everything Hashem said we will do and hear" (Shemot, 24:7).

This is the promise of, " **בְּנֵי אִם עָרַבְתָּ לְרַעְדָּךְ...** " (Mishley, 1:6). If you make a promise, then you must keep it.

8) How is the parable just like what happened at *Har Sinai*?

Let's Review Words from the Other Booklets.

Write the number of the Hebrew meaning next to its English meaning.

	get (got)	לומר	.1
	a <u>second</u> set of	אודות הבגדים של	.2
1	say (said)	יהיה שם	.3
	make (made)	הפרשה הזו	.4
	will be <u>there</u>	של הלוחות	.5
	<u>this</u> <i>parasha</i>	לקבל	.6
	<u>about</u> the clothes of	לעשות	.7
	<u>of</u> The Tablets	סט שני של	.8

Translate words to Hebrew.

1. to walk	ללכת
2. arrive at	
3. had	
4. a smile	
5. tonight	
6. to leave	
7. bread	
8. immediately	
9. to stay	
10. to believe	

Your New Words

New Word	Meaning	Your Practice Sentence
1.		
2.		
3.		
4.		
5.		
6.		
7.		
8.		
9.		
10.		
11.		
12.		
13.		
14.		
15.		
16.		

17.		
18.		
19.		
20.		
21.		
22.		
23.		
24.		
25.		
26.		
27.		
28.		
29.		
30.		
31.		
32.		
33.		
34.		
35.		

My Glossary

* מילים בסוגריים () הן בצורת העבר.

A a		B b	
about	אודות	baby	תינוק
above	מעל	bad	רע
according to	לפי	bag	תיק
action	פעילות	be	להיות
add	להוסיף	beat	להביס
afraid	מפחד	beautiful	יפה
after	אחרי	because	כי
again	שוב	because of	בגלל
agree	להסכים	become	להפוך להיות
all	כל	bed	מיטה
all night	כל הלילה	bedroom	חדר שינה
alone	לבד	before	לפני
also	גם	begin (began)	להתחיל
always	תמיד	below	למטה
animal	חיה	bench	ספסל
another	אחר	the best	הטוב ביותר
answer	תשובה, לענות	birthday	יום הולדת
any	כל, שום	blessing	ברכה
anything	שום דבר	bone	עצם
anyway	בכל אופן	book	ספר
appear	להופיע	bookcase	ארון ספרים
arrive	להגיע	was born	נולד
article	מאמר	both	שניהם
as	כמו, כאשר	bottom	תחתית
ask	לשאל	bowl	סיר, קערה
at	ב...	box	קופסה
at all	בכלל לא	boy	ילד
at least	לפחות	bread	לחם
author	מחבר	bring (brought)	להביא
		brother	אח
		build (built)	לבנות
		bunk bed	מיטת קומתיים
		busy	עסוק
		but	אבל
		by	ליד
		by accident	בטעות

C c		D d	
cabinet	ארון מטבח	date	תאריך
called	נקרא	day	יום
camel	גמל	deal with	לעסוק
can	יכול	decide	להחליט
candle holder	מחזיק נרות	desk	שולחן עבודה
celebrate	לחגוג	destroy	להרוס
center	מרכז	dig	לחפור
chart	טבלה	dining room	פינת אוכל
cheer	להריע	dip	לטבול
chief	ראשי	different	שונה
child	ילד, ילדה	difficult	קשה
children	ילדים	discuss	לשוחח
choose (chose)	לבחור	do (did)	לעשות
circle	להקיף בעיגול	donkey	חמור
city	עיר	door	דלת
class	כיתה, שיעור	doven	להתפלל
close	קרוב	dress up	להתחפש
closer	יותר קרוב	drink (drank)	לשתות
closet	ארון בגדים	during	במשך
clothes	בגדים		
collect	לאסוף		
color	צבע		
come (came)	לבוא		
come back	לחזור		
come out	לצאת		
come over	לבוא		
comfortable	נוח		
comment	פירוש, הערה		
competition	תחרות		
complete	להשלים		
condition	תנאי		
connection	קשר		
continue	להמשיך		
copy	להעתיק		
correct	נכון		
correctly	בצורה נכונה		
costume	תחפושת		
couch	ספה		
could	יכל		
cow	פרה		

E e		F f	
each	כל	face	פנים
egg	ביצה	fast	לצום
Egypt	מצרים	fast	מהר
eight	שמונה	a few	קצת
enemy	אויב	famous	מפורסם
enough	מספיק	feel (felt)	להרגיש
else	אחר	feel better	להרגיש טוב יותר
erase	למחות\ למחוק	festive	חגיגי
even though	אע"פ	foot (feet)	רגל
evening	ערב	field	שדה
every	כל	festive	חגיגי
everybody	כולם	final	סופי
everyone	כל אחד	fifth	חמישי
explain	להסביר	find (found)	למצוא
except for	חוץ מ...	fight (fought)	להלחם
the end	הסוף	fill in	למלא
		final	סופי
		fine	בסדר
		finish	לגמור
		first	ראשון
		fish	דג
		five	חמש
		follow	לפי
		food	אוכל
		for	בשביל, ל...
		for example	לדוגמה
		forget (forgot)	לשכוח
		forty	ארבעים
		four	ארבע
		fourth	רביעי
		from	מ...
		full	מלא
		funny	מצחיק

G g		H h	
game get (got) get paid give (gave) glass go (went) go after go back go down go out go up golden good luck	משחק לקבל, להגיע לקבל תשלום לתת כוס, זכוכית ללכת לנסות להשיג לחזור לרדת לצאת, לכבות לעלות מזהב בהצלחה	half hand happen happy happier happiness has has to have (had) have to (had to) he head help her hear (heard) here hide hidden him his holiday home homeless hope horse hot how how much however husband hurt (v)	חצי יד לקרות שמח יותר שמח שמחה יש לו \ לה חייב יש ל... חייב הוא ראש לעזור שלה לשמוע כאן להחביא נסתר אותו שלו חג בית לקוות חסר בית סוס חם כמה איך אולם בעל לפגוע
I i		J j	
if I'm sure immediately important in in fact in front of include information inside instead of interested in it it doesn't matter its	אם אני בטוח מיד חשוב ב... בעצם מול לכלול מידע בתוך במקום מעוניין ב... הוא \ היא \ זה זה לא משנה שלו \ שלה	judge just just like	לשפוט רק בדיוק כמו

K k		L l	
kettle king kitchen know (knew) known as	קומקום מלך מטבח לדעת ידוע כ...	land last long law learn leave (left) left lend (lent) letter life light (n) like line listen live look look like look at look for a lot of	אדמה נשאר זמן רב חוק ללמוד לעזוב, לצאת\להשאיר שמאל להלוות אות, מכתב חיים אור לחבב\ כמו שורה, קו להקשיב לחיות, לגור נראה להראות להסתכל על לחפש הרבה
M m		N n	
maid make (made) make a mistake man many master match (v) me measure meal (I) mean meaning meat message milk miracle money month more most the most move to mule must my	משרתת להכין, לעשות, לגרום לטעות איש הרבה אדון להתאם אותי למדוד ארוחה להתכוון פירוש בשר הודעה, מסר חלב נס כסף חודש יותר, עוד הכי הכי הרבה לעבור ל... חמור חייב שלי	name natural near need never next nice night now number nation	שם טבעי ליד צריך מעולם לא הבא נחמד לילה עכשיו מספר, למספר עם, אומה

O o		P p	
of often old olive on on time on top of one of once one only order other our oven own (my own, your own ...) oil	של לעתים קרובות זקן, ישן זית על בזמן מעל אחד מ... פעם, פעם אחת אחד רק סדר אחר שלנו תנור שלי שמן	page part party participate pay (paid) people person picture place placed plate play play a joke on phrase poor practice praise pray present pure	עמוד חלק מסיבה להשתתף לשלם אנשים בנאדם תמונה למקום, מקום ממוקם קערה לשחק לעשות שחוק מ... ביטוי עני להתאמן לשבח, שבח להתפלל מתנה טהור
Q q		R r	
question	שאלה	rain reach read (read) ready really refrigerator remind reason remember rent repeat reply represent review rich right right before road roasted rock	גשם להגיע לקרוא מוכן באמת מקרר להזכיר סיבה לזכור לשכור לחזור על... להגיב לייצג לחזור על עשיר ימין מיד לפני כביש צלוי אבן

S s			
sad	עצוב		
salt	מלח		
save (money, time)	לחסוך		
say (said)	לומר		
seat	כיסא		
second	שני		
see (saw)	לראות		
sell (sold)	למכור		
send (sent)	לשלוח		
sentence	משפט		
separate	להפרד		
set of tablets	לוחות הברית		
set up	לסדר		
should	כדאי ש...		
show	להראות		
shul	בית כנסת		
side	צד		
simple	תם		
sink	כיור		
sit	לשבת		
sleep (slept)	לישון		
small	קטן		
smile	חיוך		
snake	נחש		
so	אז		
so too	גם כן		
son	בן		
sound	צליל		
speak	לדבר		
special	מיוחד		
spend time (spent)	לבלות		
split	לבקוע		
stage	שלב, במה		
star	כוכב		
start	להתחיל		
stay	להשאר		
stick	מקל		
still	עדיין		
story	סיפור		
strong	חזק		
study	ללמוד		
suddenly	פתאום		
suggestion	הצעה		
sun	שמש		
surprised	מופתע		
the same	אותו דבר		

T t			
table	שולחן	travel	לנסוע
Table of Commandments	לוח הברית	translate	לתרגם
tablecloth	מפת שולחן	tree	עץ
take (took)	לקחת	trouble	צרות
take out	להוציא	try	לנסות
teach (taught)	ללמד	turn into	להפוך ל...
teacher	מורה	two	שתיים
tell (told)	לספר	type (n,v)	סוג, להקליד
test	מבחן		
text	טקסט		
that	ההוא\ ש...		
the	ה...		
their	שלהם		
them	אותם		
than	מ...		
then	אז		
there	שם		
there is	יש		
there is no	אין		
there are	יש		
therefore	לכן		
these	אלו		
they	הם		
thing	דבר		
think (thought)	לחשוב		
third	שלישי		
this	זה		
those	אלו		
thought	מחשבה, חשב		
through	דרך...		
throw (threw)	לזרוק		
throw off	לזרוק מ...		
time	זמן		
thirteenth	השלושה עשר		
tip	עצה		
tired	כותרת		
title	עייף		
to	ל...		
today	היום		
together	ביחד		
tonight	הלילה		
too	גם		
too much	יותר מדי		
top	עליון		
town	עיר		
tree	ע		

U u		V v	
uncle under underline understand us usually use (v) used for	דוד מתחת למתוח קו מתחת להבין אותנו בדרך כלל להשתמש שומשו כ...	very vinegar visit volunteer	מאד חומץ לבקר להתנדב
W w		X x	
wait walk want was watch water way we wear (wore) were what when where which who why wicked wife window wise with without word work worker world would burn write (wrote) written	לחכות ללכת ברגל לרצות היה לצפות מים דרך אנחנו ללבוש היו מה, איזה מתי, כאשר איפה איזה מי, ש... למה רשע אישה חלון חכם עם בלי מילה עבודה, לעבוד פועל עולם ידלק לכתוב כתוב		
Y y		Z z	
year years old you your yourself	שנה בן אתה, אתם שלך, שלכם עצמך	zeide	סבא (בידיש)